

# CSCE 247 - Object Modeling Activity

Name(s):

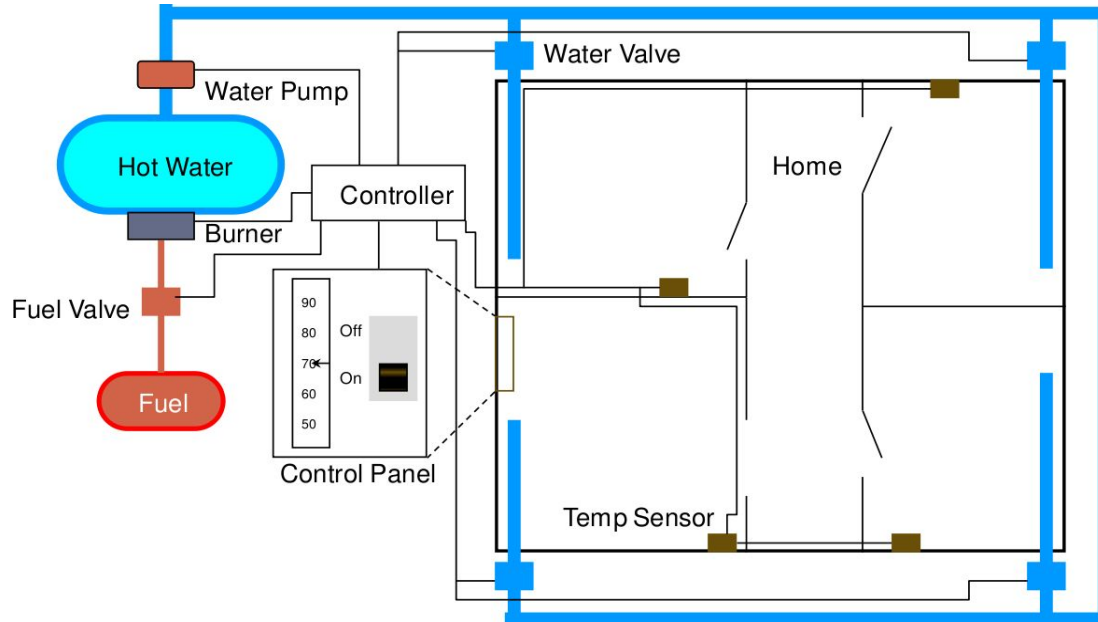

The purpose of the software for the Home Heating System is to control the heating system that heats the rooms of a house. The software shall maintain the temperature of each room within a specified range by controlling the heat flow to individual rooms.

**You have the following requirements for the system:**

- The software shall control the heat in each room
- The room shall be heated when the temperature is 2F below desired temp
- The room shall no longer be heated when the temperature is 2F above desired temp
- The flow of heat to each room shall be individually controlled by opening and closing its water valve
- The valve shall be open when the room needs heat and closed otherwise
- The user shall set the desired temperature on the thermostat
- The operator shall be able to turn the heating system on and off
- The furnace must not run when the system is off
- When the furnace is not running and a room needs heat, the software shall turn the furnace on
- To turn the furnace on the software shall follow these steps
  - open the fuel valve
  - turn the burner on
- The software shall turn the furnace off when heat is no longer needed in any room
- To turn the furnace off the software shall follow these steps
  - close fuel valve
  - turn burner off

**You also have the following information about the physical design of the hardware:**

- A room consists of a thermometer and a radiator.
- A radiator consists of a valve and a radiator element.
- The home heating system consists of a furnace, rooms, a water pump, a control panel, and a controller.
- The furnace consists of a fuel pump and a burner.
- The control panel consists of an on-off switch and a thermostat.
- The controller controls the fuel pump, the burner, and the water pump. It monitors the temperature in each room, and opens and closes the valves in the rooms.
- The operator sets the desired temperature, and turns the system on and off.
- The controller gets notified of the new desired temperature.

**1. From the requirements, come up with an initial list of objects or classes for the system.**

**2. Eliminate unnecessary classes. Look for those that are redundant, irrelevant, vague, attributes of another class, operations, roles, or implementation details. For each class you removed, give a reason why you removed it.**

**3. Choose at least three of the classes and write the data dictionary for each defining the purpose of the class and some of the attributes or operations it might have.**

**4. Derive associations and complete the class diagram.**